

PARTS LIST		
PART NUMBER	ITEM	MATERIAL
1a	Pen Cap	Brass, Soft Yellow
1b	Pen Main Body	Aluminum
1c	Pen End Piece	Brass, Soft Yellow

1	Drawing Number: 1 Drawn By: Swaleh Owais (TMJ-3MH)	UNLESS OTHERWISE SPECIFIED : - All Dimension Are In Inches - Tolerance on All Lengths are : ± .010 Inches - Tolerance on All Diameters are : ± .005 Inches	TITLE: Pen Explosion Drawing	
	Teacher: Mr. Tempelmann		DATE: October 10th 2014	
			SCALE: 3:4	MATERIAL: Brass and Aluminum

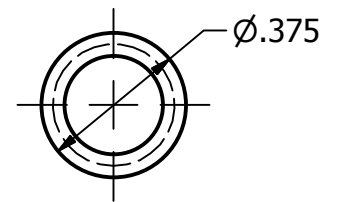
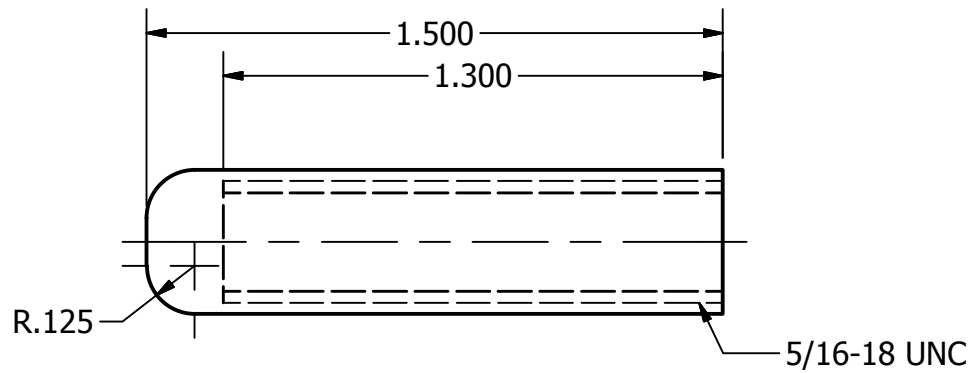

Drawing Number:

1a

Drawn By: Swaleh Owais (TMJ-3MH)

Teacher: Mr. Tempelmann

UNLESS OTHERWISE SPECIFIED :

- All Dimension Are In: Inches
- Tolerance on All Lengths are: $\pm .010$ Inches
- Tolerance on All Diameters are: $\pm .005$ Inches

TITLE: Pen Cap Drawing

DATE: October 10th 2014

SCALE: 2:1 MATERIAL: Brass

DETAIL A
SCALE 4 : 1

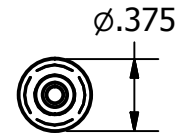
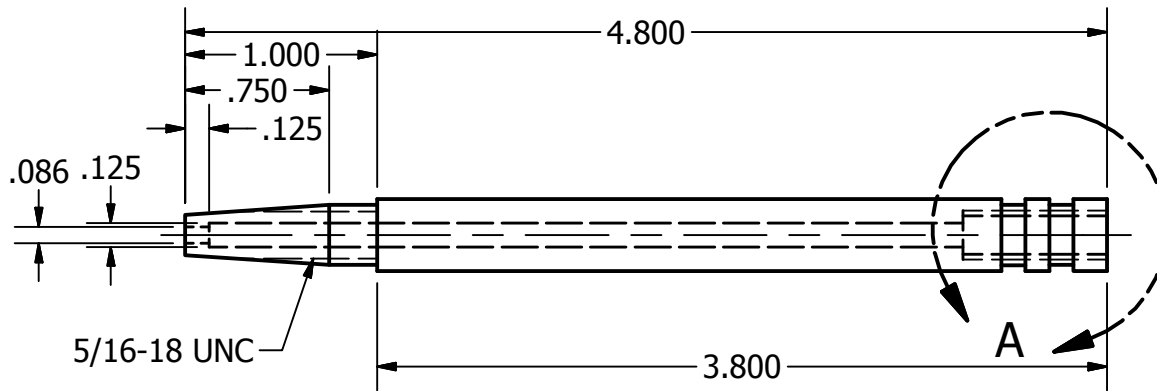
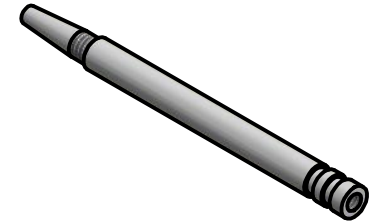
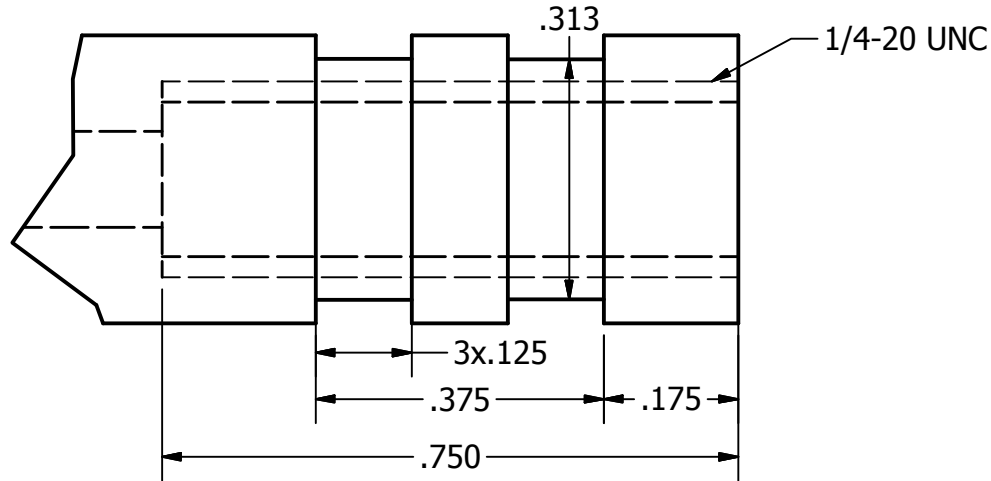

Drawing Number:

1b

Drawn By: Swaleh Owais (TMJ-3MH)

Teacher: Mr. Tempelmann

UNLESS OTHERWISE SPECIFIED :

- All Dimension Are In: Inches
- Tolerance on All Lengths are: $\pm .010$ Inches
- Tolerance on All Diameters are: $\pm .005$ Inches

TITLE: Pen Main Body Drawing

DATE: October 10th 2014

SCALE: 1:1 MATERIAL: Aluminum

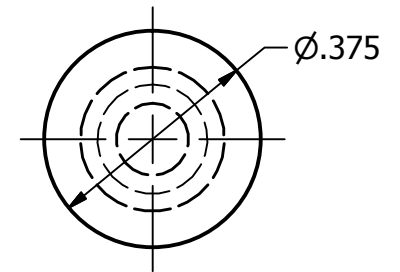
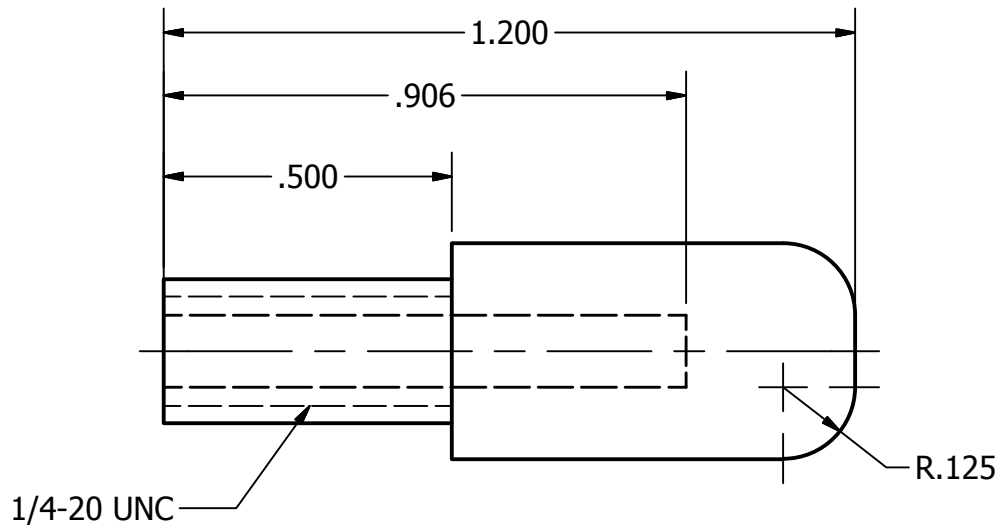

Drawing Number:

1c

Drawn By: Swaleh Owais (TMJ-3MH)

Teacher: Mr. Tempelmann

UNLESS OTHERWISE SPECIFIED :

- All Dimension Are In: Inches
- Tolerance on All Lengths are: \pm .010 Inches
- Tolerance on All Diameters are: \pm .005 Inches

TITLE: Pen End Piece Drawing

DATE: October 10th 2014

SCALE: 3:1 MATERIAL: Brass